

## BASIC PAPER FOLDING

Fold upwards one after the other.

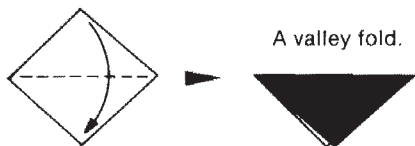

A valley fold.

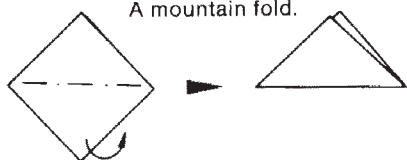
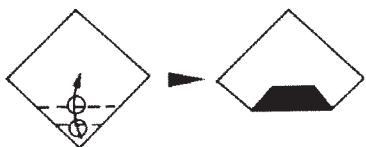

A mountain fold.



Enlargement

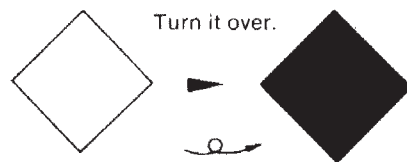

Turn it over.



Fold it inwards.

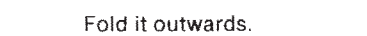

Fold it outwards.

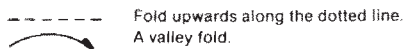

Fold upwards along the dotted line.  
A valley fold.

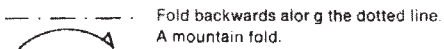

Fold backwards along the dotted line.  
A mountain fold.

## BIRD

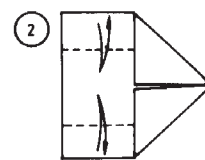
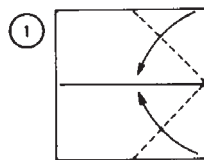

Open paper after folding.

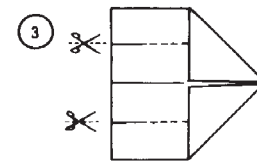

Cut the folding line.

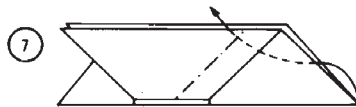
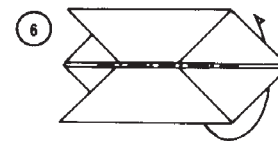
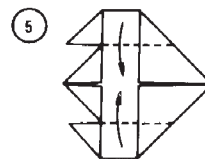
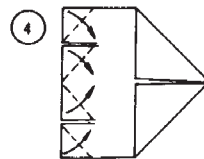

Fold it inwards.

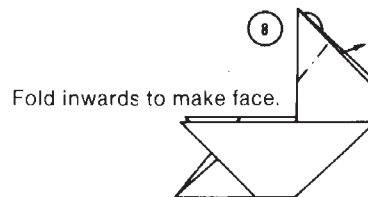

Fold inwards to make face.

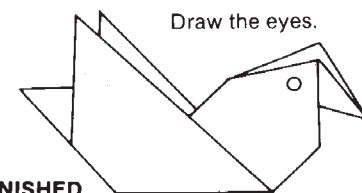

Draw the eyes.

**FINISHED**

## STAR

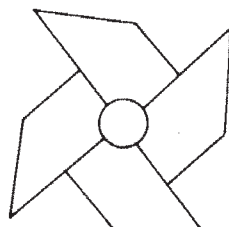
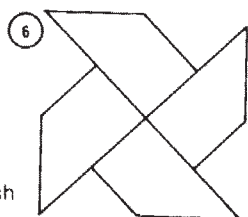
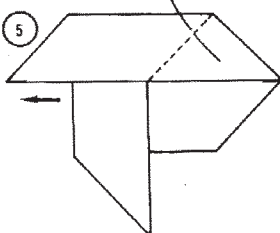
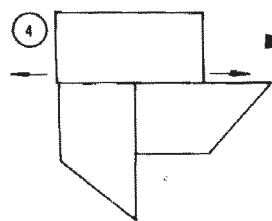
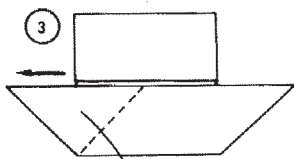
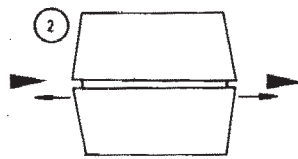
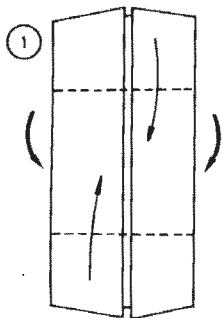

Put sticker on to finish the star.

**FINISHED**

## GOLD FISH

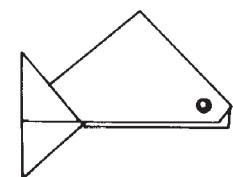
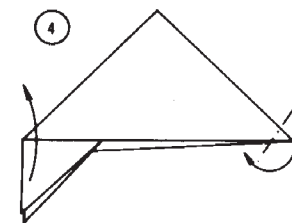
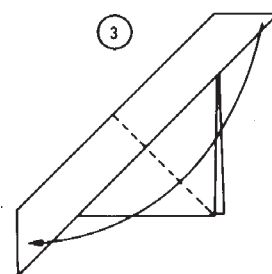
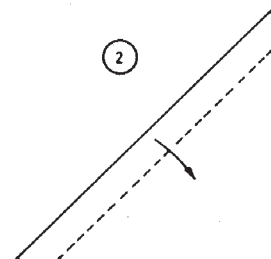
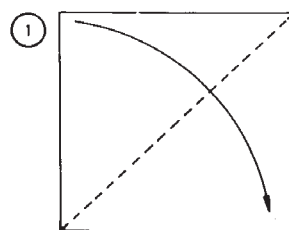

**FINISHED**

### HOUSE

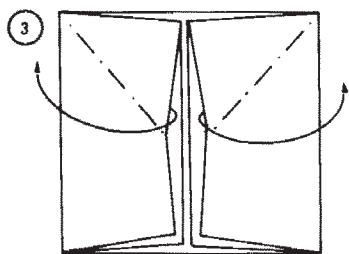
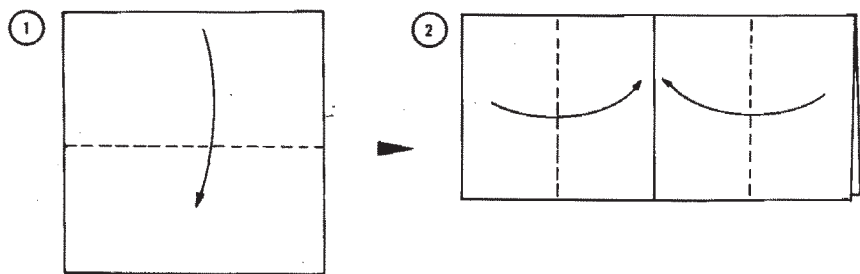

FINISHED



### FISH

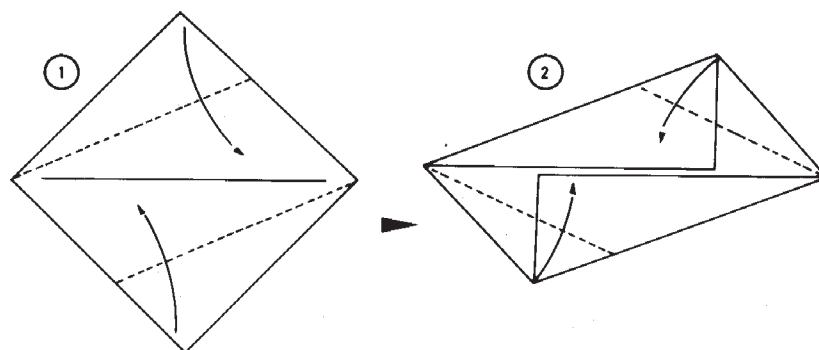

Begin after folding to make the center line.

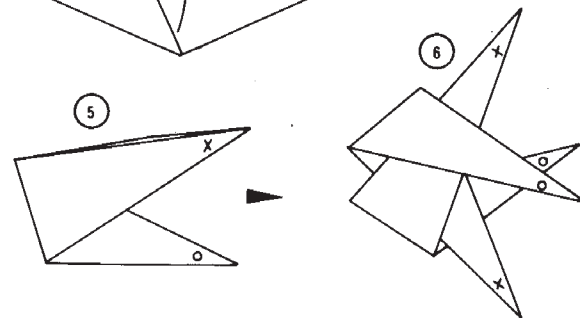
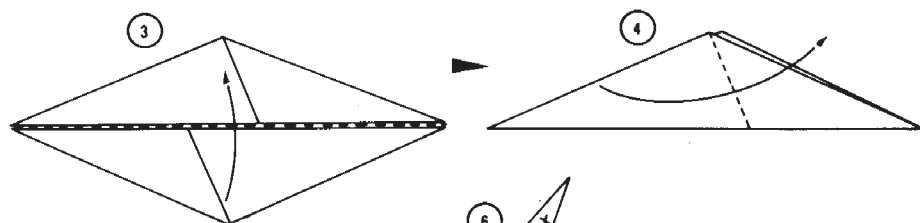

○ Long triangle.  
X Short triangle.

Make 2 of the same shape and paste them.

FINISHED

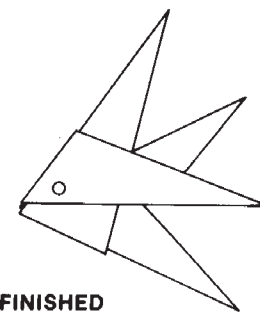

### HAT

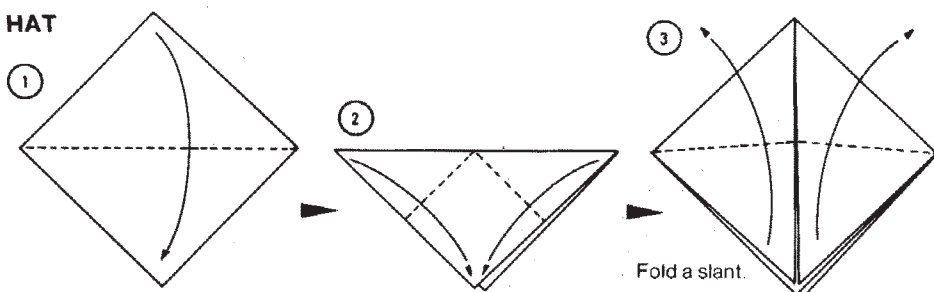

Fold a slant.

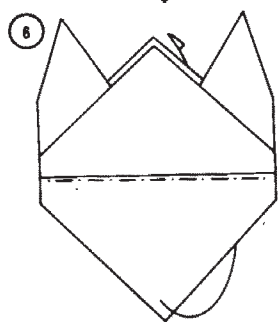
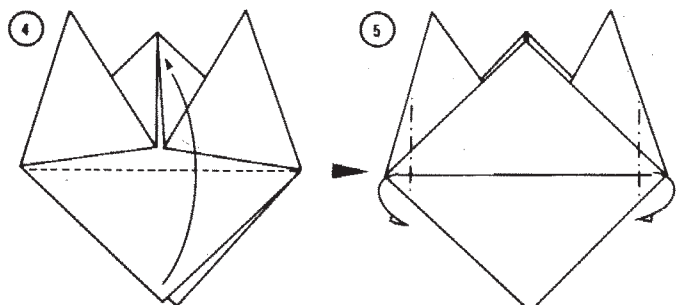

FINISHED

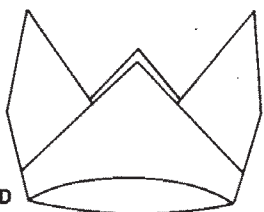

### OCTOPUS

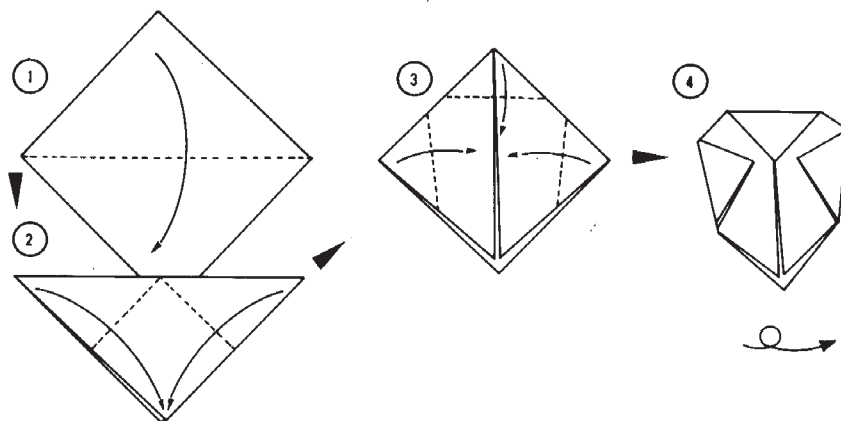

Head

Legs

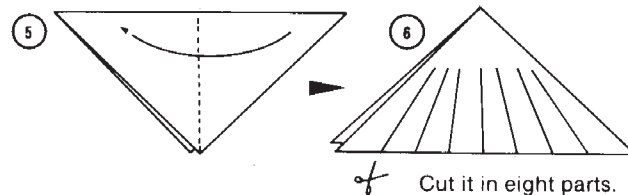

Cut it in eight parts.

Paste the head onto the legs.

FINISHED

